

Installation guide for STS-200, STS-201, STS-212

1. opening hole size

1. STS-200

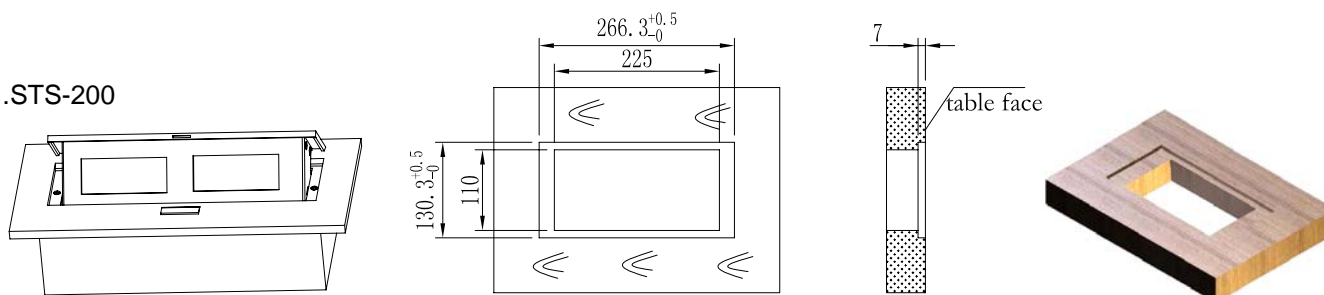

Opening hole modle

2. STS-201

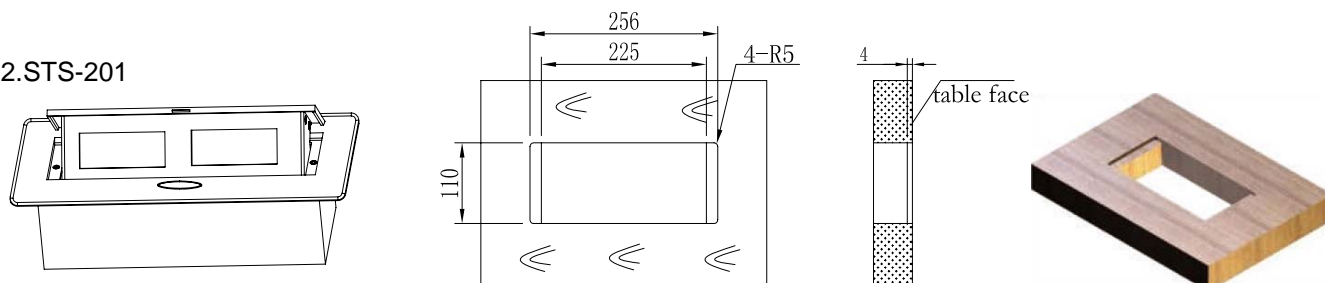

Opening hole modle

3. STS-212

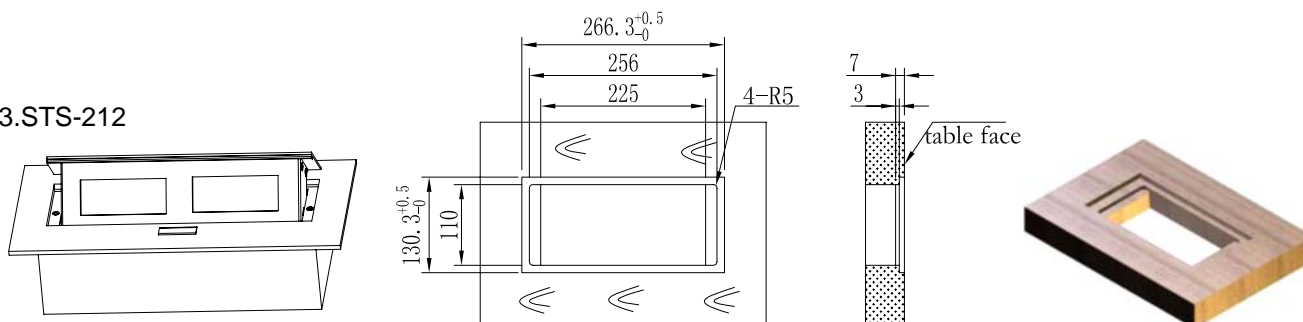

Opening hole modle

2. step for installation

- A. Remove the two screws,seperate the bottom box and cover plate.
Ref: Pic 1

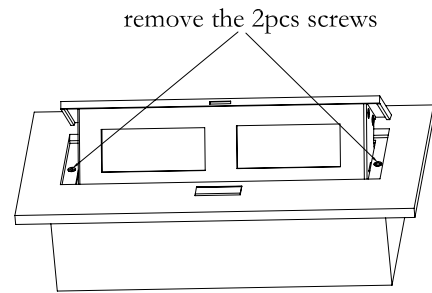

Pic 1

- B. Install the bottom box into the apponinted palce firmly with screws(like officetabletop, metope,ground,etc c).
Ref: Pic 2

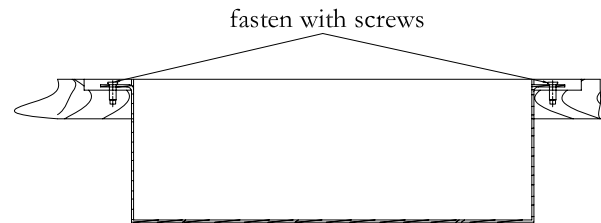

Pic 2

- C. Remove the 3pcs screws and metal clip (as pictrure showed).Then remove the plastic frame,which is for fixing the sockets.
Ref: Pic 3

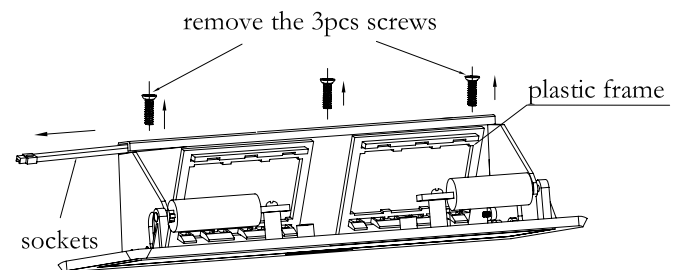

Pic 3

- D. Assemble the socket into the plactic frame.
Step(1) install top or bottom of socket into the frame
Step(2) press the socket and frame to the direction as the picture showed to make them combine tightly
Ref: Pic 4

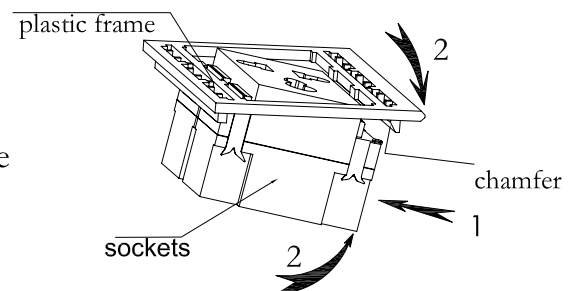

Pic 4

- E. Assemble the plastic frame,which are filled with sockets into the metal box,then inset the metal clip and fasten the screws.
Ref: Pic 5

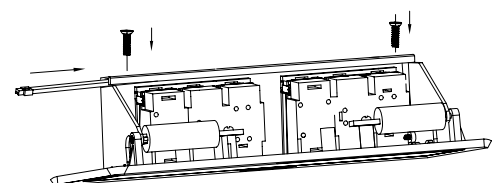

Pic 5

- F. Keeping the inner power sockets connected by power wire (the power wire must be copper core cord-1.5mm²9-20, and the length should guarantee opening well).adding earth wire,and keep the power wires tightly with the sockets.
Ref: Pic 6

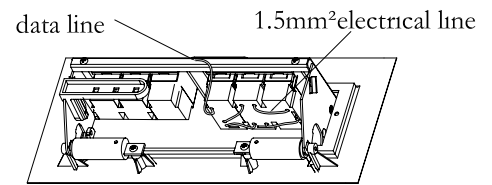

Pic 6

- G. Connecting all the wires 【Power wire or Data wire, Phone line,TV receiving line,sound box wire(the wire should be in the), as required】 relatively with the relevant sockets,then fasten the screw.Adjusting the wires'length, then tighten the strip and shave the superabundance length of wrap.
Ref:Pic 7

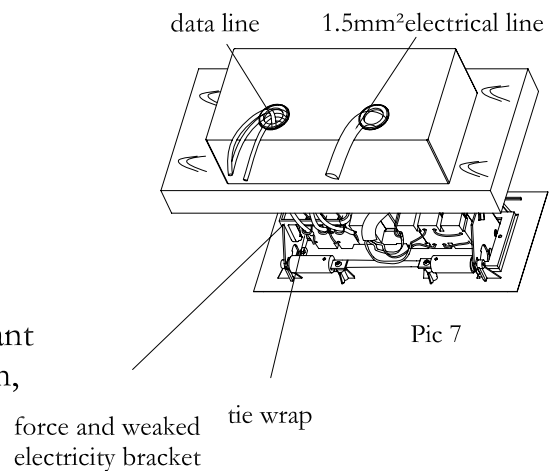

Pic 7

- H. Lock the two screws on both sides tightly.
Ref:Pic 8

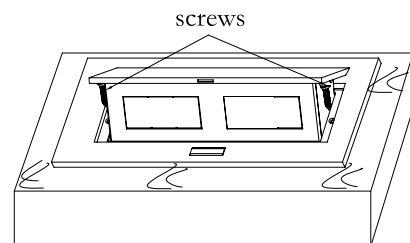

Pic 8

- I. Adjust the degree of tightness of all line(no influence on opening),install press plate,and lock it tightly with screws .
Ref:Pic 9

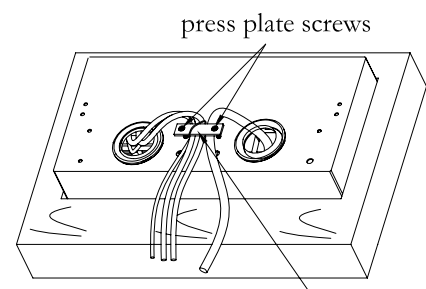

Pic 9

Notice:

- (1).Indoor use only.
- (2).The product is moistureproof.
- (3).After press the button,the box will open slowly.
When it opens completely,it can be used.
- (4).Use row-socket when the electricity is strong,fasten the band on the weaked electrical bracket when the electricity is weak.
- (5).User must connect it with the earth line.
- (6).Installation of the product must follow the instruction strictly.